

Installation Manual

HYUNDAI TUCSON 5DR
HYU-TUCS-5-C



COMPONENTS INCLUDED

SHADES

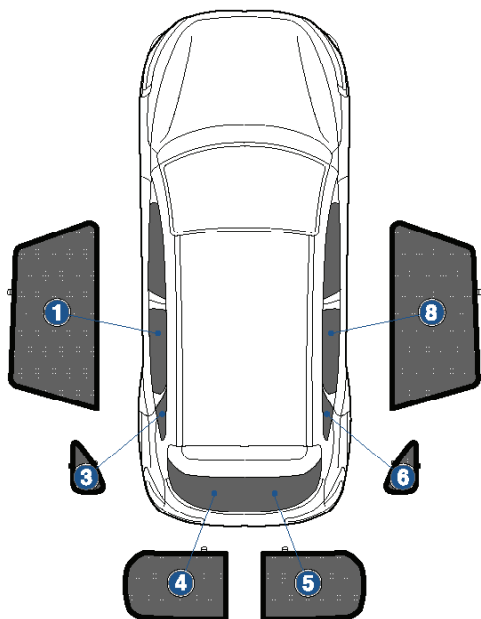

FIXING CLIPS



CL-M02 x 4



CL-M12 x 4



CL-M13 x 4



CL-M14 x 1

Side Shade Installation

HYUNDAI TUCSON 5DR
HYU-TUCS-5-C

COMPONENTS NEEDED:



STEP #1

ATTACH CLIPS ON SHADE EDGES

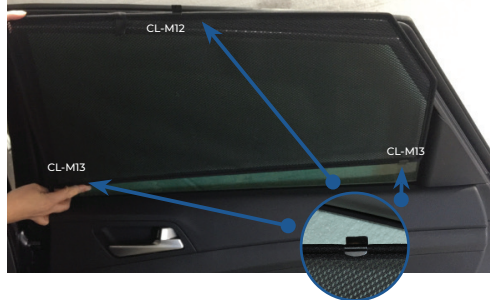

STEP #2

POSITION THE SIDE SHADE

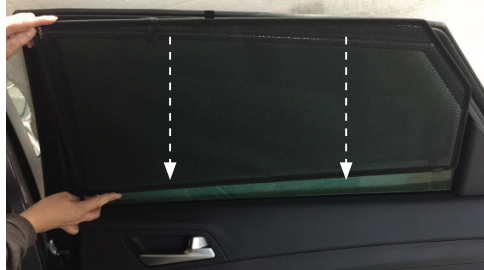

STEP #3

INSERT CLIPS INSIDE WEATHERSTRIP

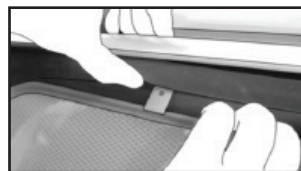

STEP #4

ENSURE SECURELY FITTED IN PLACE

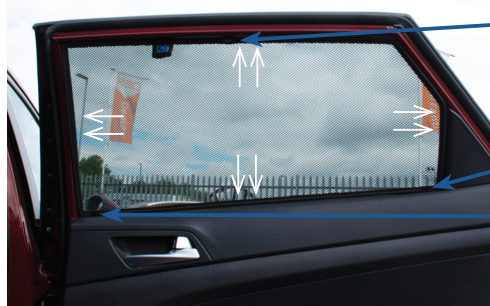

Quarter Light Shade Installation

HYUNDAI TUCSON 5DR
HYU-TUCS-5-C

COMPONENTS NEEDED:



STEP #1

ATTACH CLIPS ON SHADE EDGES



STEP #2

INSERT CLIPS BEHIND INTERIOR TRIM



STEP #3

ENSURE SECURELY FITTED IN PLACE

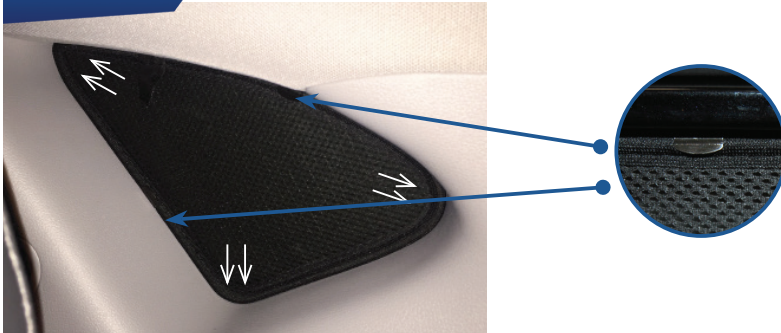

CAR
SHADES

Rear Shade Installation

HYUNDAI TUCSON 5DR
HYU-TUCS-5-C

COMPONENTS NEEDED:

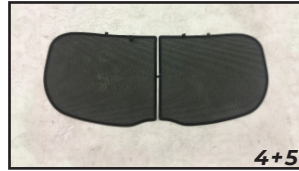

STEP #1

ATTACH CLIPS ON SHADE EDGES



STEP #2

POSITION THE REAR SHADE

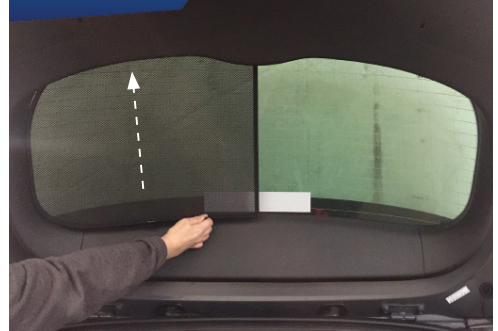

STEP #3

INSERT CLIPS BEHIND INTERIOR TRIM

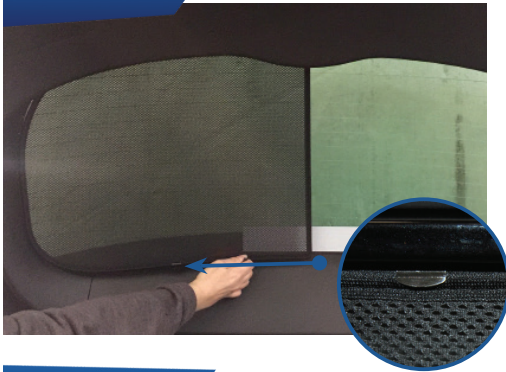

STEP #4

REPEAT THE PROCESS ON OTHER SHADE

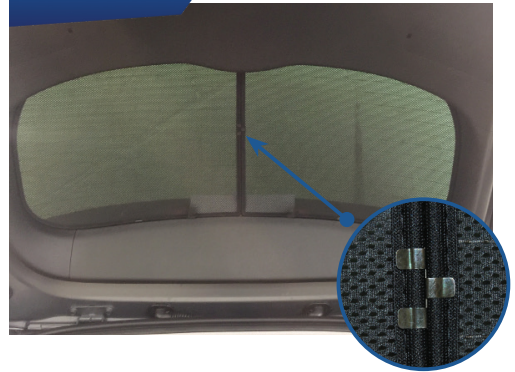

STEP #5

ENSURE SECURELY FITTED IN PLACE

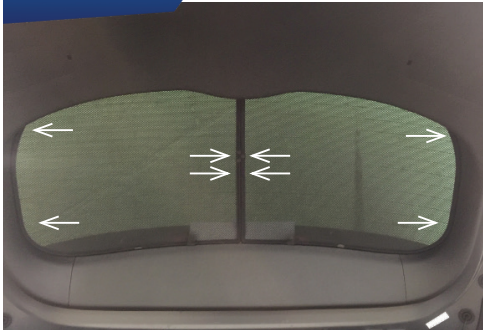

CAR
SHADES