

Support Bracket
41.0507

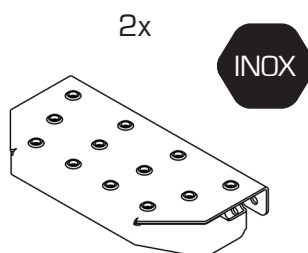

Step
41.0509

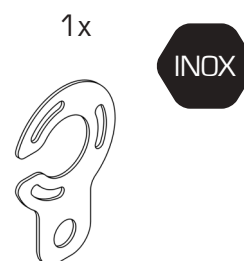

S150 113
41.3219

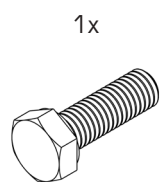

M16x60
20.0651 - Elv. 10.9

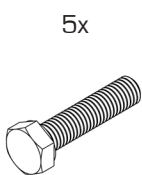

M10x50
20.0629 - RVS



M10
20.0521 - RVS

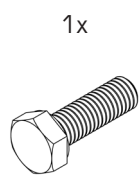

M10x35
20.0567 - RVS

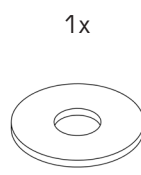

M10(x30)
20.0517- RVS



M10
20.0569 - RVS



25x20x12.6
20.0581



M10
20.0233

Carefully checked by: _____

Packaging Date: _____

17 - M10
T43 Nm

24 - M16
T270 Nm



Aan alle technische tekeningen kunnen geen rechten worden ontleend, maatvoering kan afwijken van de realiteit.
No rights can be derived from these technical drawings, sizes may differ from reality.
Aucuns droits ne peuvent être dérivés de tous les dessins, dimensions peuvent différer de la réalité.
Alle technischen Zeichnungen können keine Rechte abgeleitet werden, Abmessungen können von der Realität abweichen.

1

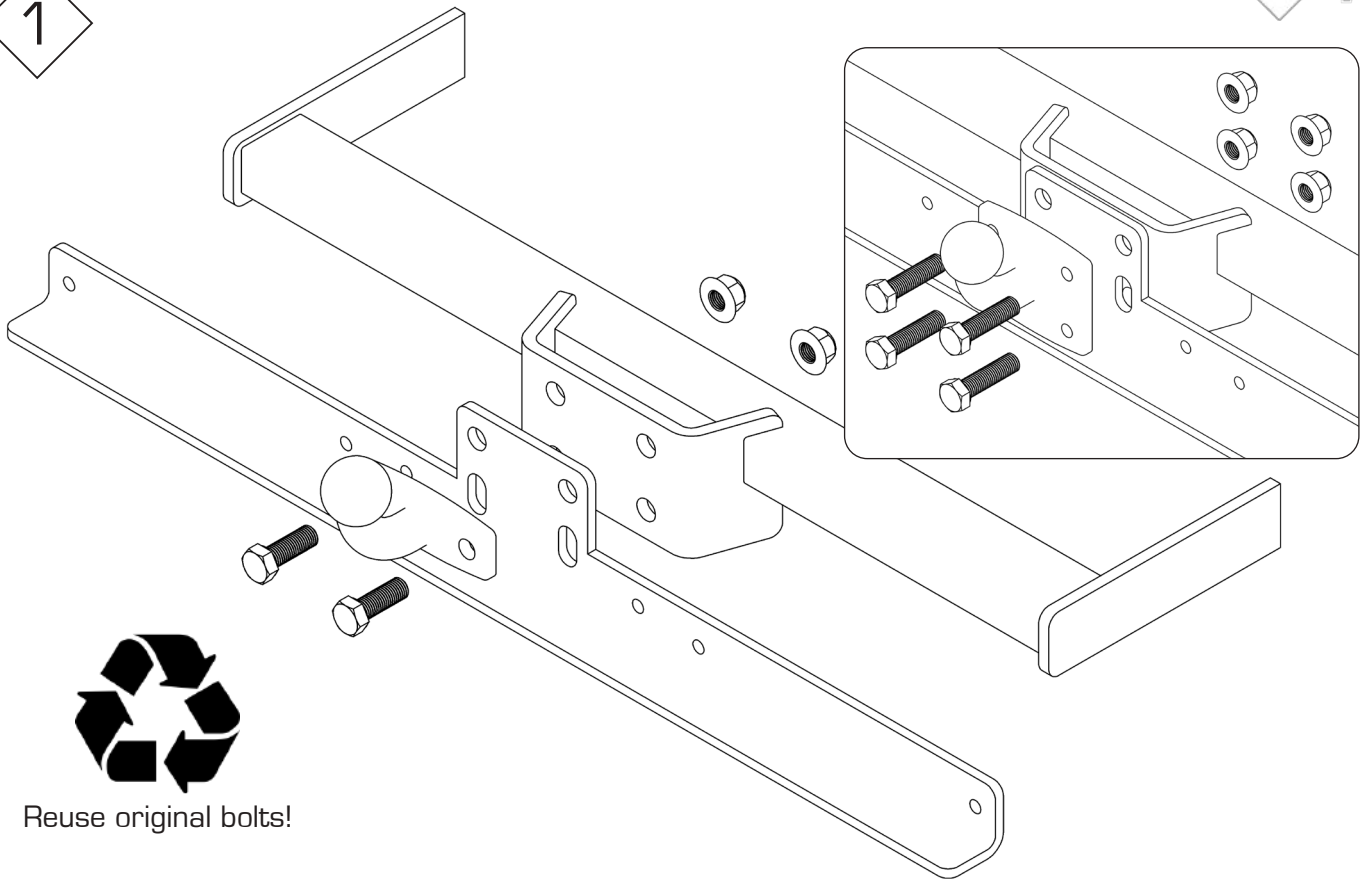

Reuse original bolts!

2

TwoStep Left		TwoStep Right	
		<p>1x</p> <p>M10x35 20.0567 - RVS</p>	<p>1x</p> <p>M10(x30) 20.0517 - RVS</p>
		<p>1x</p> <p>M10 20.0569 - RVS</p>	<p>1x</p> <p>M10 20.0521 - RVS</p>

Towhook

<p>1x</p> <p>M16x60 20.0651 - Ev. 10.9</p>
--

Option spacer

<p>1x</p> <p>M10x50 20.0517 - RVS</p>	<p>1x</p> <p>M10(x30) 20.0517 - RVS</p>	
<p>1x</p> <p>M10 20.0569 - RVS</p>	<p>1x</p> <p>M10 20.0521 - RVS</p>	<p>1x</p> <p>25x20x12,6 20.0581</p>

3

