

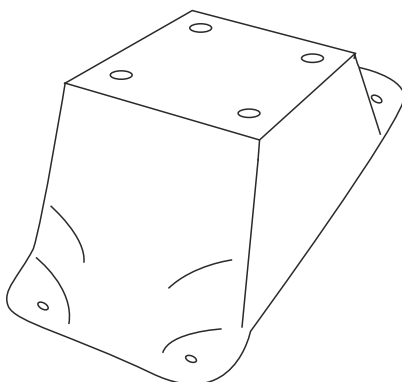

OPEL MERIVA FLEXRAIL 2010-2017

with FlexRail

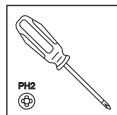
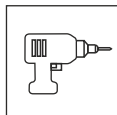
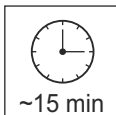

A

B

C

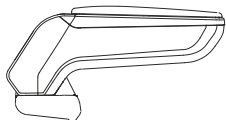

armster **S**

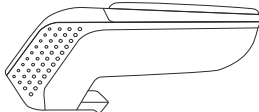

armster **2**

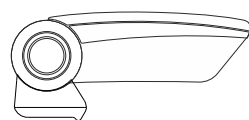

armster **3**

V01744



4x



M5x16

4x



M5

4x



M5

1x



00200

